

ART 735-A MK4

ACTIVE TWO-WAY SPEAKER

DESCRIPTION

The ART 735-A MK4 is a unique speaker in its category. The titanium dome, 3.0" voice coil neodymium compression driver offers a unique vocal clarity and sound projection. The 15" neodymium woofer offers an extremely linear response and a precise, deep low frequency control. The transducers are produced using the most advanced assembly technologies. The amplifier delivers 1400 watts and is controlled by a DSP that takes care of crossover, equalisation, phase control, soft limiting and speaker protections.



FEATURES

- 132 dB Max SPL
- 1400 WATT 2-way peak power
- Innovative DSP Processing
- 3" Titanium Compression Driver, 3.0" v.c. Neodymium
- 15" Neodymium Woofer
- 800 Hz crossover point for perfect vocal reproduction
- 90°x60°, wide dispersion constant directivity horn
- FiRPHASE Technology

TECHNICAL SPECIFICATIONS

| | | |
|----------------------------------|----------------------------|-------------------------|
| Acoustical specifications | Frequency Response: | 45 Hz ÷ 20000 Hz |
| | Max SPL @ 1m: | 132 dB |
| | Horizontal coverage angle: | 90° |
| | Vertical coverage angle: | 60° |
| Transducers | Compression Driver: | 1 x 1.4" neo, 3.0" v.c |
| | Woofers: | 15", 3.0" v.c |
| Input/Output section | Input signal: | bal/unbal |
| | Input connectors: | XLR, Jack |
| | Output connectors: | XLR |
| | Input sensitivity: | -2 dBu/+4 dBu |
| | Mic. Input Sensitivity: | -32 dBu |
| Processor section | Crossover Frequencies: | 800 Hz |
| | Protections: | Thermal, RMS |
| | Limiter: | Soft Limiter |
| | Controls: | Volume, Boost, Mic/Line |
| Power section | Total Power: | 1400 W Peak, 700 W RMS |
| | High frequencies: | 400 W Peak, 200 W RMS |
| | Low frequencies: | 1000 W Peak, 500 W RMS |
| | Cooling: | Convection |
| | Connections: | VDE |
| Standard compliance | Safety agency: | CE compliant |
| Physical specifications | Cabinet/Case Material: | PP Composite |
| | Hardware: | 2 x M10 |
| | Handles: | 1 Top, 2 Side |
| | Pole mount/Cap: | Yes |
| | Grille: | Steel |
| | Color: | Black |
| Size | Height: | 708 mm / 27.87 inches |
| | Width: | 437 mm / 17.2 inches |
| | Depth: | 389 mm / 15.31 inches |
| | Weight: | 21.4 kg / 47.18 lbs |
| Shipping information | Package Height: | 750 mm / 29.53 inches |
| | Package Width: | 500 mm / 19.69 inches |
| | Package Depth: | 440 mm / 17.32 inches |
| | Package Weight: | 24.4 kg / 53.79 lbs |



PART NUMBER

• **13000529**

ART 735-A MK4

115V

EAN 8024530014926

• **13000528**

ART 735-A MK4

220-240V

EAN 8024530014742

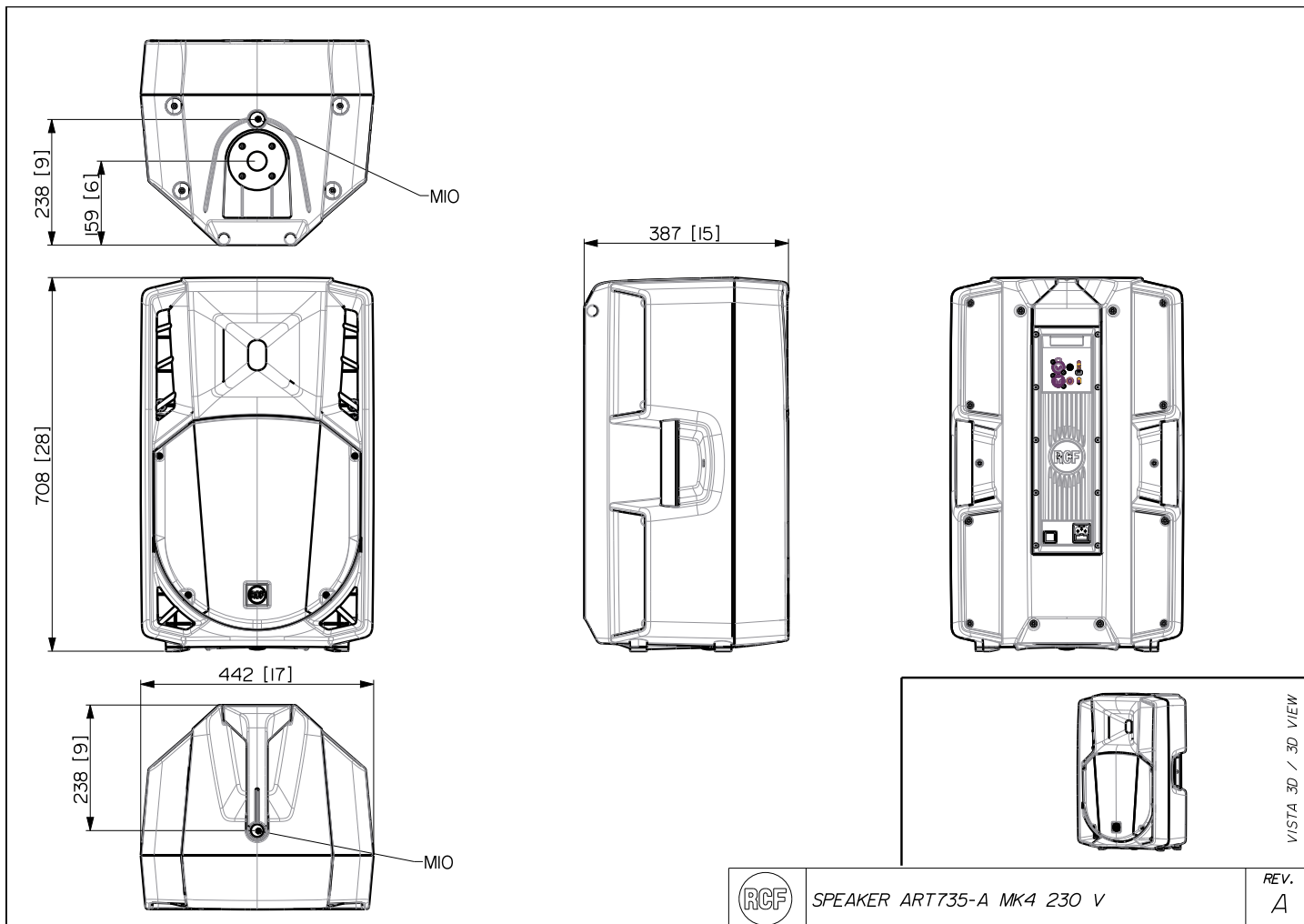

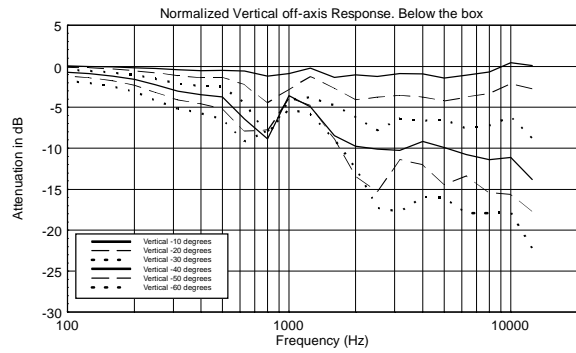
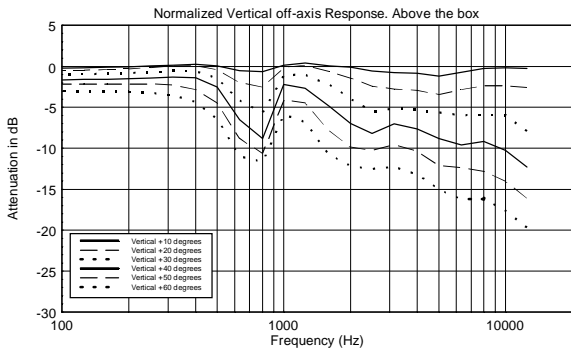
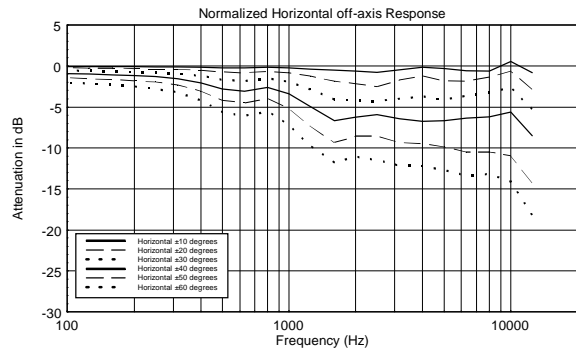
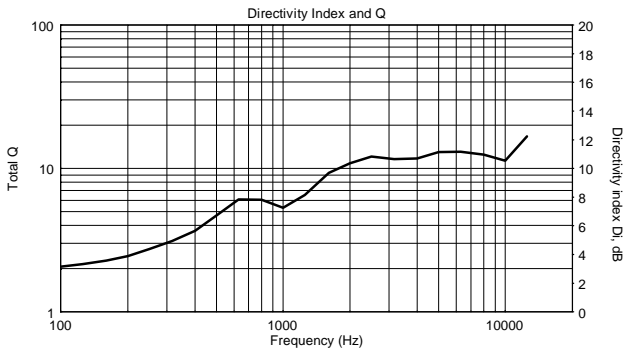
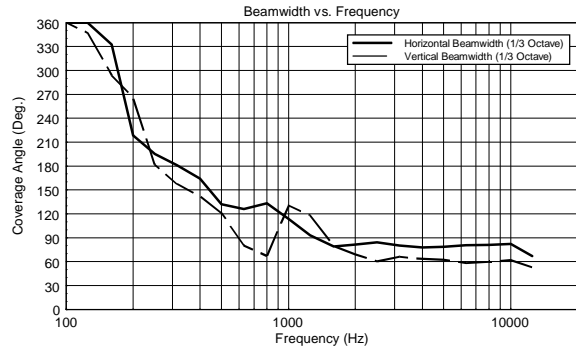
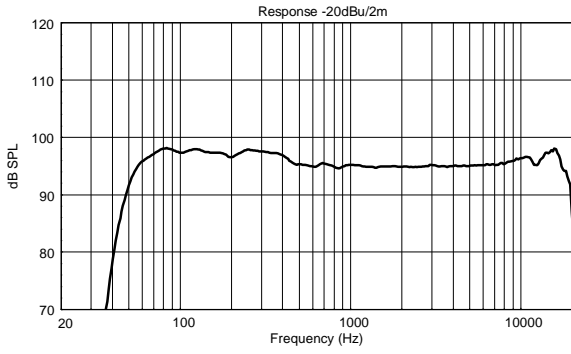

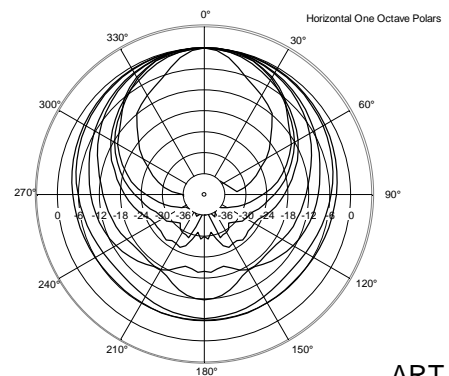
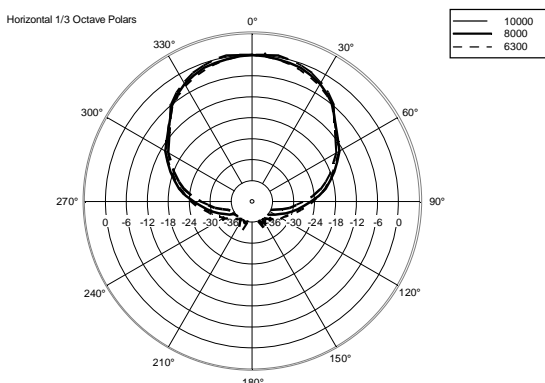
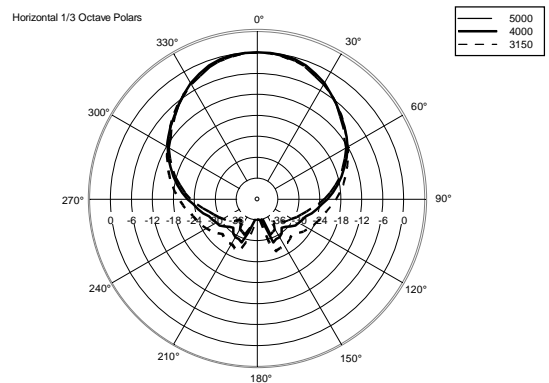
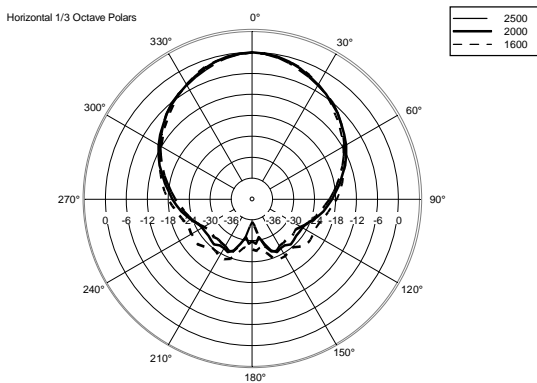
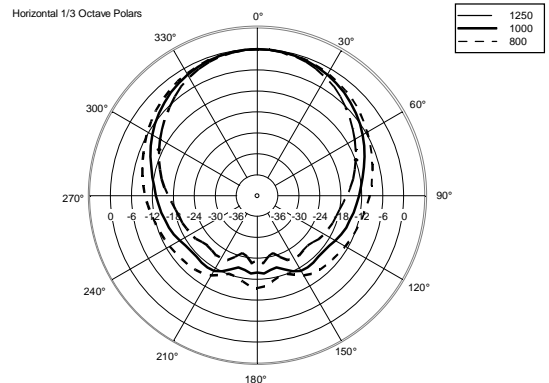
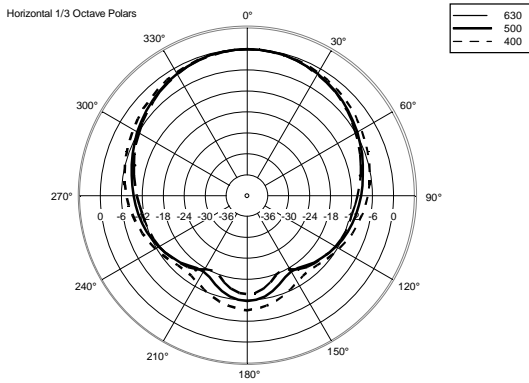
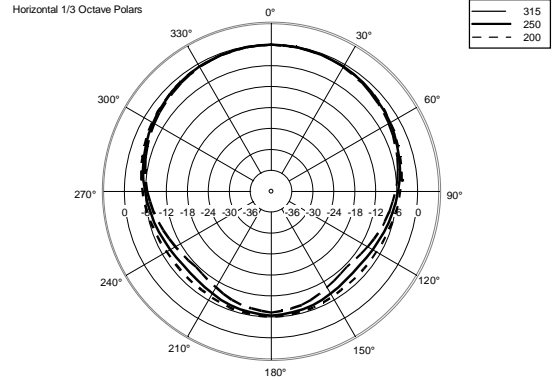
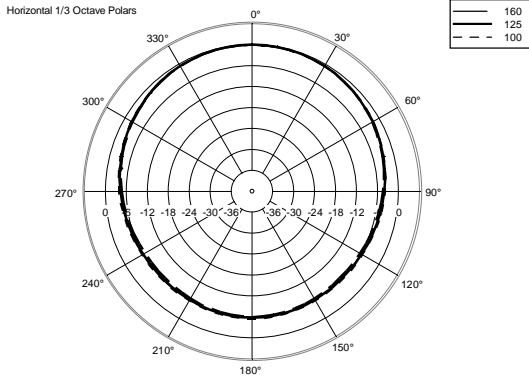

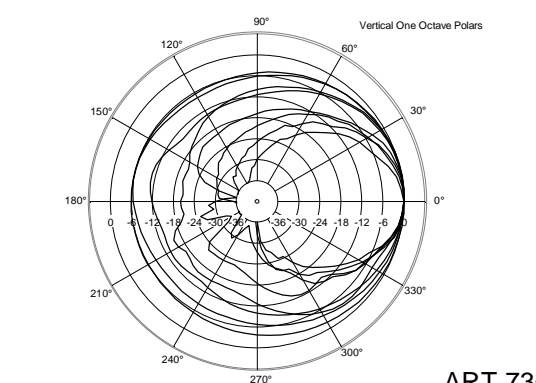
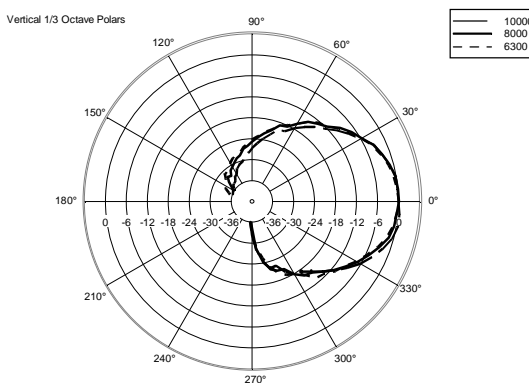
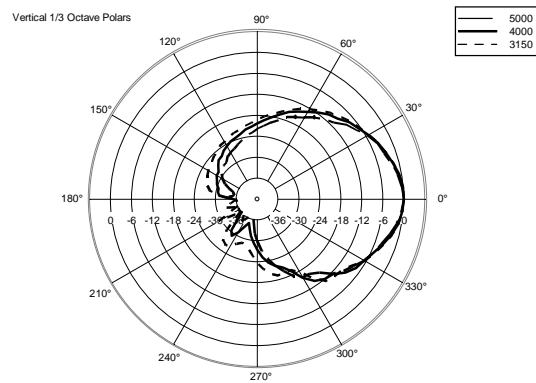
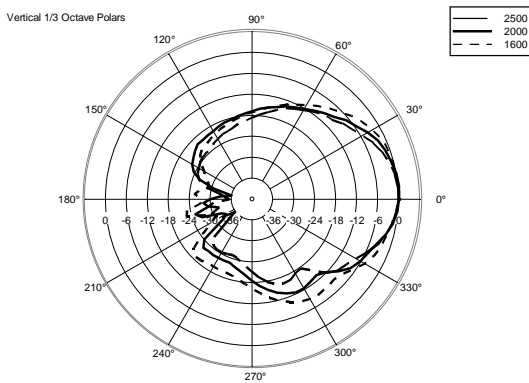
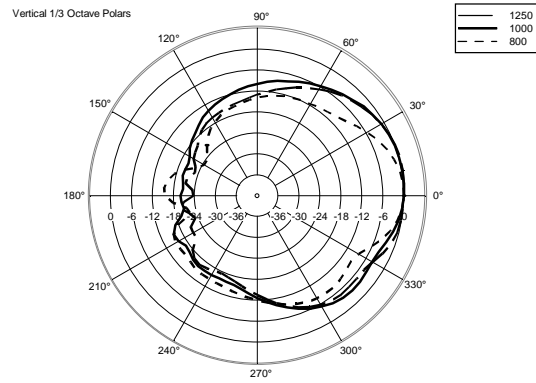
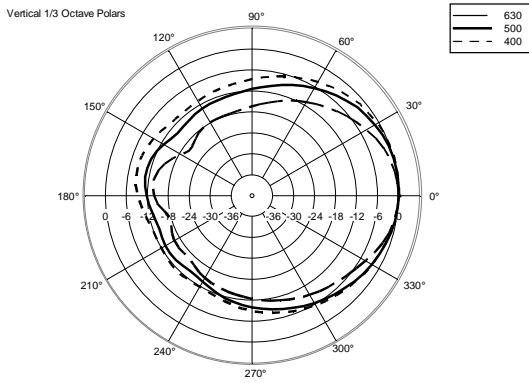
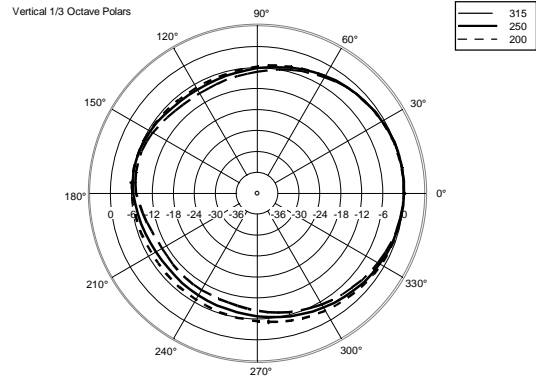
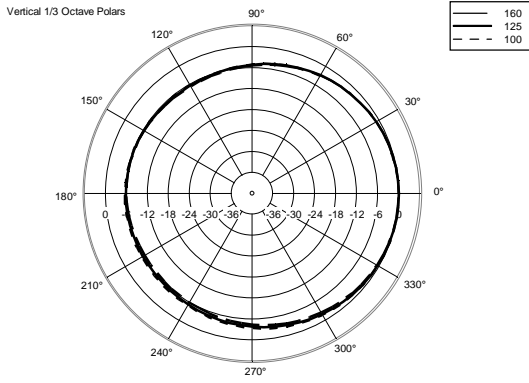

ACCESSORIES

AC PM-M20

PART NUMBER **13360067**
EAN: 8024530014599

AC PMX POLE MOUNT M20

PART NUMBER **13360232**
EAN: 8024530010058

AC PRO-FS PROFESS. LOCKING FLOOR STAND

PART NUMBER **13360109**
EAN: 8024530006471

AC PRO-PM PROFESS. LOCKING POLE MOUNT

PART NUMBER **13360110**
EAN: 8024530006488

COVER CVR ART 725

PART NUMBER **13360115**
EAN: 8024530010676

HORIZONTAL BRACKET H-BR 2X ART 715

PART NUMBER **13360105**
EAN: 8024530012939