

APPLICATIONS

- Live sound PA system or Live sound monitor, DJ system
- School and corporate audio visual sound reinforcement
- Background music/announcement: Restaurants, Pubs
- Transportation terminals, Clubs, Auditorium, Theatres
- Gyms, Houses of worship

FEATURES

- 15mm / 5/8" baltic birch plywood cabinet
- Recommended amplifier 800W RMS / 8 Ohm
- 15" B&C neodymium woofer with 3" voice coil
- 1" exit B&C neodymium driver with 1.7" voice coil
- 80° H x 50° V rotatable horn
- Input panel with 2 x Neutrik speakon NL-4MDV in & link
- SPL capability: 132dB
- 12 x M10 fly points
- Completely Manufactured in Italy

PASSIVE REINFORCEMENT SPEAKER

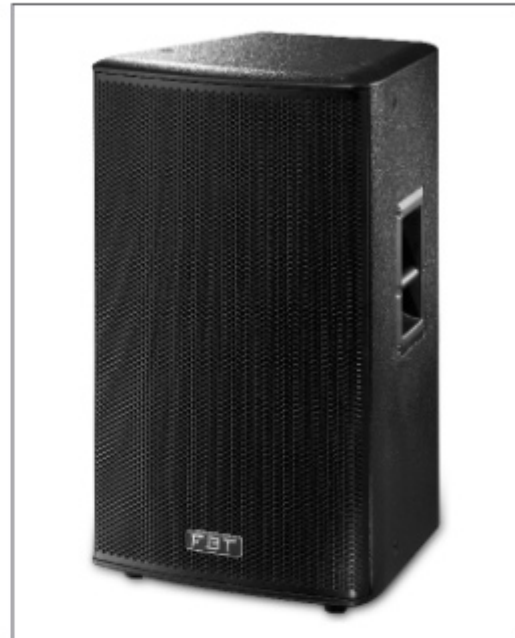

PRODUCT DESCRIPTION

The FBT MITUS 115 two-way passive reinforcement speaker system shall incorporate 1 x 15" B&C neodymium woofer with 3" voice coil and 1" exit B&C neodymium driver with 1.7" voice coil coupled to a rotatable 80° x 50° horn; thanks to the rotatable HF horn it is possible to create horizontal arrays of 2 enclosures for a total coverage of 130°. The FBT MITUS 115 shall meet the following performance criteria: Frequency response of 50Hz to 18kHz, Frequency sensitivity of 100dB, Maximum SPL of 132dB, Recommended power amplifier 800W RMS / 8 Ohm. The FBT MITUS 115 passive speaker feature 0.59" baltic birch plywood construction covered in a scratch & scuff resistant black finish; the front shall be protected by a heavy duty metal grille with anti-resonance spacers and exclusive synthetic cloth to protect the drivers. The hi-grade passive internal crossover featuring «soft-trip» circuitry protection of the LF woofer and HF driver. Input connectors shall be parallel wired Neutrik NL4 speakon. The 12 M10 anchoring points built into the cabinet allow the FBT MITUS 115 speaker to be surface mounted on ceilings and a standard 1.38" speaker stand socket allows the FBT MITUS 115 to be mounted on speaker stands.

ELECTRICAL PERFORMANCE

System Type:	2-way
Recommended Amplifier	800W RMS
Long Term Power (AES)	400W
Short Term Power (IEC 268-5)	1400W
Nominal Impedance	8 Ohm
Frequency Response @ -6dB	50Hz - 18kHz
Sensitivity @ 1W, 1m	99dB
Maximum SPL *	CONT. 128dB PEAK 132dB
Dispersion	80°H x 50°V
Crossover Frequency	1.5 kHz
Recommended HP filter	40Hz-24dB oct.

PHYSICAL

Low Frequency Woofer	1 x 15" - 3" coil
High Frequency Driver	1 x 1" - 1.7" coil
Input Connectors	2 x Speakon NL4 in & thru
Net Dimensions (WxHxD)	16.7" x 29.5" x 16.6"
	425 x 750 x 421 mm
Shipping Dimensions (WxHxD)	22.04" x 33.85" x 21.65"
	560 x 860 x 550 mm
Net Weight	57.3 lbs / 26 kg
Shipping Weight	62.8 lbs / 28.5 kg
Enclosure Material	0.59" birch plywood

* CONT. SPL: free space, based on recommended amp rating and LF transducer average sensitivity data, 125mS time average
PEAK SPL: free space, based on short term applicable power rating and system peak sensitivity, 10mS time average

DIAGRAMS

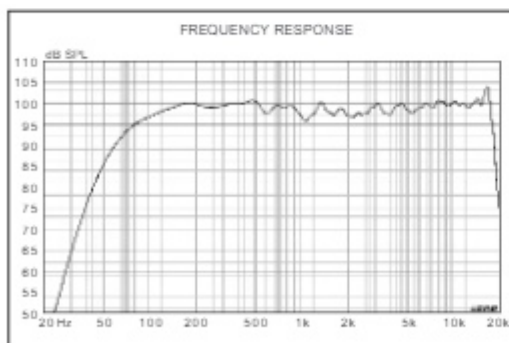
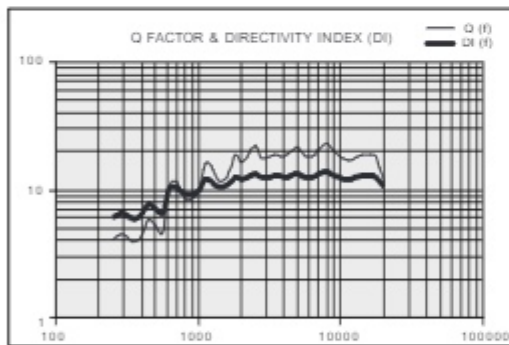
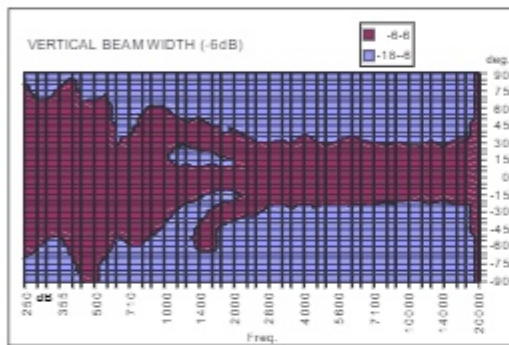
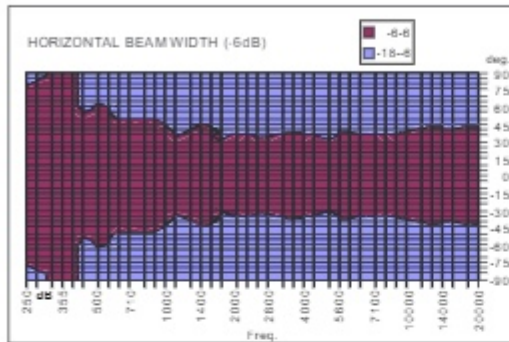

HORIZONTAL POLAR DIAGRAM

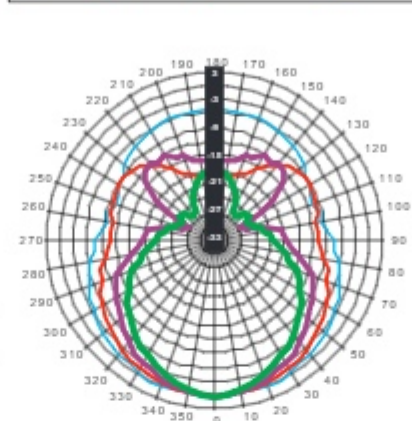

HORIZONTAL POLAR DIAGRAM

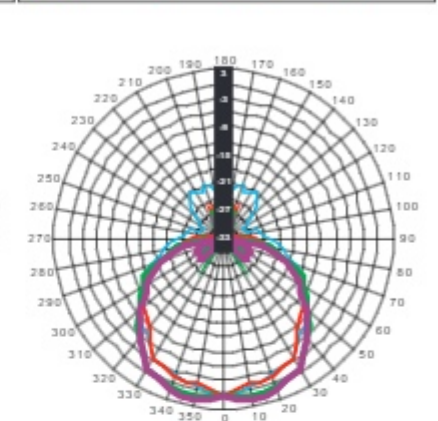

VERTICAL POLAR DIAGRAM

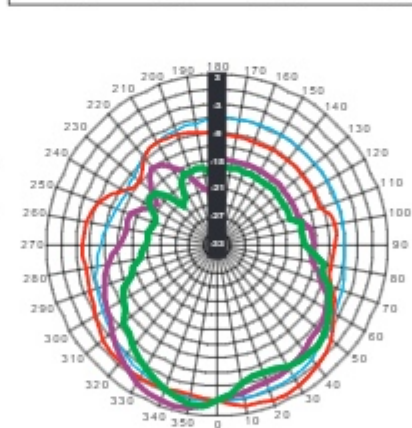

VERTICAL POLAR DIAGRAM

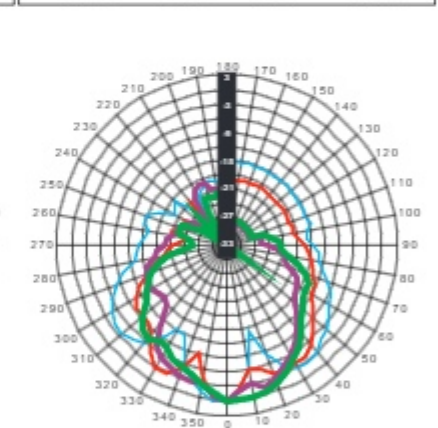

VERTICAL POLAR DIAGRAM

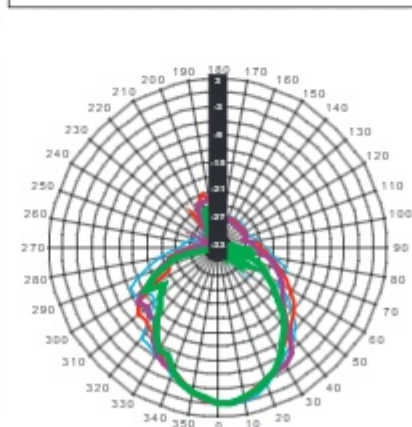

VERTICAL POLAR DIAGRAM

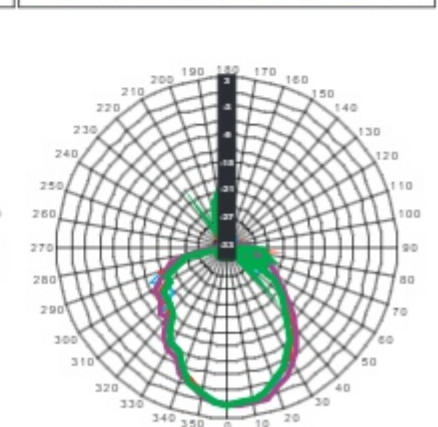

CONNECTORS

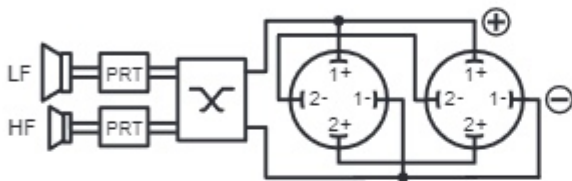

ACCESSORIES

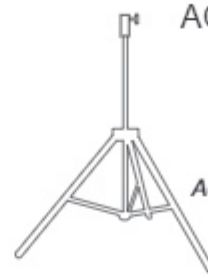

BOX 22BK

Adjustable aluminum floor stand
Ø 1.38" with Ø 1" adapter
max. weight 88lb.



BOX 62BK

Adjustable for sub-satellite
speaker connection with
safety locking device Ø 1.38" M20



BOX 32BK

Adjustable aluminum floor stand
damped safety mechanism
max. weight 154lb.

CONNECTION PANEL

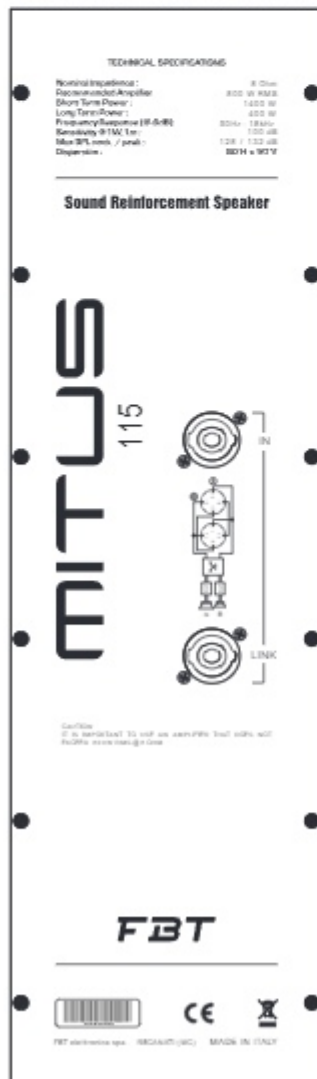

DIMENSION DRAWING

