

DESCRIPTION

20W two way bass reflex speaker unit

The PROJECT 320, made of ABS with a front metal grille, utilizes a compact two-way system guaranteeing high performances, wide dynamics, high fidelity sound reproduction and high voice intelligibility. These speaker units are equipped with an exclusive fully adjustable support bracket for easy installation, to cut costs and save installation time. The bracket may be attached to the wall prior to installing the loudspeaker and is provided with a safety cable. Connection to the loudspeakers is via plug in "Euroblock" connector and adjustment of loudspeaker output is made via screwdriver adjustable switch.

SPECIFICATIONS

Rated power	20W
Adjustable power	20 - 15 - 8 - 4W
Impedance	8 Ohm
Loudspeakers	1 woofer + 1 tweeter (bass-reflex)
Sound pressure SPL (Pnom/1m)	103dB
Sensitivity (1W,1m)	87dB
Frequency response	100 ÷ 15.000Hz
Dispersion angle @2kHz	120°
Mounting	Wall mounting bracket (included)
Colour	Project WHT: white RAL 9010 Project BT: black RAL 9005
Dimensions	143 x 204 x 162mm
Weight	1,5kg

PROJECT 320
ABS SPEAKER SYSTEM

POWER SWITCH & EUROBLOCK CONNECTOR

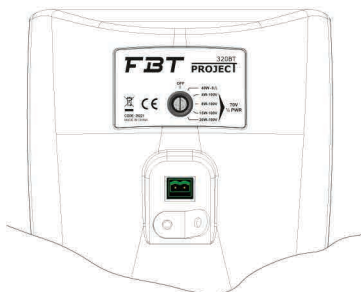

The speaker can be connected to audio lines at constant voltage (100V / 70V) or with constant impedance (8 Ohm)

DIMENSIONS

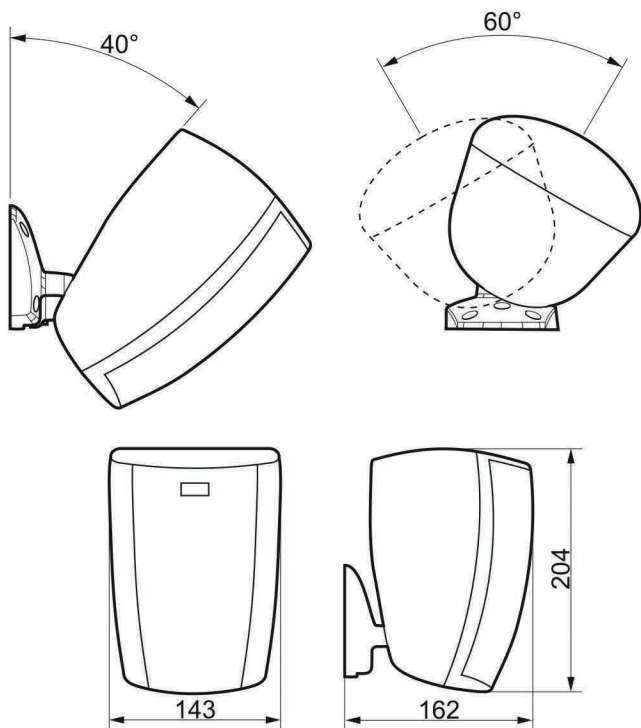

FREQUENCY RESPONSE

